

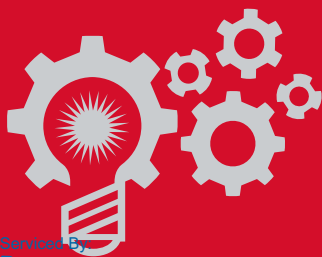

Catalog LP01ENe

# Linear Products



Sold & Serviced By  
**ELECTROMATE**

Toll Free Phone (877) SERV008

Toll Free Fax (877) SERV009

[www.electromate.com](http://www.electromate.com)

[sales@electromate.com](mailto:sales@electromate.com)

## Linear

AxialPower Series

## Drives

SA-Series

DA-Series

SC-Series



For over 60 years, ElectroCraft has been helping engineers translate innovative ideas into reality – one reliable motor at a time. As a global specialist in custom motor and motion technology, we provide the engineering capabilities and worldwide resources you need to succeed.



This guide has been developed as a quick reference tool for ElectroCraft products. It is not intended to replace technical documentation or proper use of standards and codes in installation of product.

Because of the variety of uses for the products described in this publication, those responsible for the application and use of this product must satisfy themselves that all necessary steps have been taken to ensure that each application and use meets all performance and safety requirements, including all applicable laws, regulations, codes and standards.

Reproduction of the contents of this copyrighted publication, in whole or in part without written permission of ElectroCraft is prohibited.

Designed by media & brands · [www.media-brands.de](http://www.media-brands.de)

Sold & serviced by:

 **ELECTROMATE**

Toll Free Phone (877) SERV098

Toll Free Fax (877) SERV099

[www.electromate.com](http://www.electromate.com)

[sales@electromate.com](mailto:sales@electromate.com)

## Table of Contents

Typical Applications . . . . .	3
Which Linear Product . . . . .	5
Drive Product Matrix . . . . .	6

<b>AxialPower Plus Stepper</b> . . . . .	7
APPS11M . . . . .	7
APPS17 . . . . .	9
APPS23 . . . . .	11



APPS

<b>L3-Series Stepper</b> . . . . .	13
L3S . . . . .	13



L3

<b>AxialPower Plus PMDC</b> . . . . .	15
APPD15 . . . . .	15
APPD25 . . . . .	17



APPD

<b>SA-Series</b> . . . . .	19
SA45 . . . . .	19
SA49 . . . . .	21



SA

<b>DA-Series</b> . . . . .	23
DA43 . . . . .	23
DA47 . . . . .	25



DA

<b>SC-Series</b> . . . . .	27
SCA-L . . . . .	27
SCA-S . . . . .	29



SC

System Matrix . . . . .	31
Other Products . . . . .	33
Drives Accessories . . . . .	36





## Typical applications for ElectroCraft Linear Products:

- Custom OEM applications  
(Our Specialty)
- Packaging
- Semiconductor handling and testing
- Antenna positioning
- Laboratory equipment
- Rapid prototyping machines
- Medical equipment
- Dispensing



*An ElectroCraft linear actuator with a custom mechanical configuration helps keep liquid and this business flowing.*

### Medical Dispensing Pump

**Situation:** An existing ElectroCraft customer wished to expand their line of medical dispensing pumps. Critical performance metrics included linear speed, axial force, and precise linear positioning. The customer required a wide range of output performance and input power requirements to successfully complete the “family” product offering.

**Solution:** ElectroCraft was able to design custom windings for the complete linear product offering combining both the linear actuator and leadscrew motor configurations, reducing the number of parts required yet still cover the customer’s broad range of linear speed, force, and positioning requirements.

**Results:** ElectroCraft was able to reduce inventories through design and combined this effort with a Lean manufacturing based pull-system and Kanban program to further reduce inventory while improving delivery performance regardless of the customer’s fluctuations in demand.



Sold & Serviced By



Toll Free Phone (877) SERV098

Toll Free Fax (877) SERV099

[www.electromate.com](http://www.electromate.com)

[sales@electromate.com](mailto:sales@electromate.com)

## Helicopter Autopilot

**Situation:** A manufacturer interested in introducing a completely new technology of autopilot system approached ElectroCraft for an innovative solution. Positional accuracy was critical in this application. The customer was looking for a collaborative effort into the design of the electro-mechanical device.

**Solution:** ElectroCraft modified a size 17 Linear Actuator with a custom Mil-spec cable assembly, special lead-screw insert and lubrication in order to deliver prototypes quickly. Further collaboration with our customer's innovative R&D team improved the overall performance on subsequent design iterations.

**Results:** The customer is flying high. Their concept is turned into reality as their product is being final tested and approved for flight.



*ElectroCraft helps steer the way for a new generation of helicopter auto-pilot systems.*



*The pressure is on this high powered linear actuator at the heart of this analytical instrument.*

## Chromatography Platform

**Situation:** A leading manufacturer of high end chromatography instruments needed a cost effective solution for a high pressure requirement in a new platform chromatography instrument.

**Solution:** ElectroCraft incorporated ballscrew technology into our most powerful 34 frame Linear Actuator to produce a compact, yet powerful product. Capable of generating over 900 pounds of force, this linear actuator integrates a high precision ball-nut into the rotor assembly with the ballscrew providing the positional accuracy and the high linear force needed to generate pressures in excess of 15,000 psi.

**Results:** The capability of the high force and compact linear actuator allowed the customer to expand their product into new markets and opportunities for their customer base.



Select your  
**Linear Products!**



## Linear Actuator

### Functionality:

A composite insert is permanently integrated with the motor rotor and rotates

A threaded screw traverses axially in and out of the motor body



A true Push-Pull, axially translating screw.

## Leadscrew Motor

### Functionality:

The leadscrew is permanently integrated with the motor rotor and rotates

An external nut rides back and forth along the screw length providing the push and pull



Rotating screw with an axial translating external nut.

## Guided Linear Actuator

### Functionality:

Some linear applications do not restrict the leadscrew from rotating

The Guided Linear Actuator feature restricts the screw from rotating, allowing the leadscrew to translate axially



A mechanical assist to the linear actuator to restrict the leadscrew from rotating with the rotor.

Sold & Serviced By:

 **ELECTROMATE**

Toll Free Phone (877) SERV098

Toll Free Fax (877) SERV099

[www.electromate.com](http://www.electromate.com)

[sales@electromate.com](mailto:sales@electromate.com)

## Drive Product Matrix

	Bipolar Stepper Drive		PMDC Servo Drive				
	SA4505	SA4510	DA4303	DA4709	DA4718	SCA-LS-30-03	SCA-SS-30-06
<b>Product Description</b>							
See on page	19	21	23	25	25	27	29
<b>Power Features</b>							
Min. Voltage (VDC)	11	11	11	11	11	11	11
Max. Voltage (VDC)	48	48	30	70	70	30	30
Dual Bridge MOSFET Driver	●	●	●	●	●	●	●
Switching Frequency (kHz)	50	50	Linear	50	50	50	50
Linear Output			●			●	
PWM Output				●	●		●
Trap Waveform				●	●		●
<b>Power Ratings</b>							
Peak Current	5	10	3	18	36	3	6
Nominal Current	5	10	3	9	18	3	6
Adjustable Current	●	●	●	●	●	●	●
Max Continuous Power (W)	240	480	75	1260	2520	75	150
<b>Control Modes</b>							
Max. Step Input Frequency (kHz)	40	40					
Microstepping up to 1/16	●	●					
Internal Oscillator (x8)	●	●					
External Pulse Train (5-24 Logic)	●	●					
Fallback Current	●	●					
Analog Command (VDC)	+1 to +5 VDC	+1 to +5 VDC	±10	±10	±10	±10	±10
Torque Control				●	●	●	●
I/R Compensation			●	●	●	●	●
Speed Control using Tach			●	●	●	●	●
Speed Control using Voltage			●	●	●	●	●
Speed Control using Encoder							
<b>Communication / Compliance</b>							
CE Compliance (LV Directive)	●	●	●	●	●	●	●
<b>Physical Enclosure</b>							
Totally Enclosed	●	●	●	●	●	●	●
Case Type	Book Shelf	Book Shelf	Book Shelf	Book Shelf	Book Shelf	Rack	Rack

Sold & Serviced By:



Toll Free Phone (877) SERV098

Toll Free Fax (877) SERV099

[www.electromate.com](http://www.electromate.com)

[sales@electromate.com](mailto:sales@electromate.com)

# APPS11M : ElectroCraft AxialPower™ Plus | Linear Actuator Stepper

Size	Holding Torque oz-in (Ncm)	Linear Speed inch / sec (mm / sec)	Linear Force Pounds (Newton)
NEMA 11, 1.8°	14 (10)	16 (400)	32 (140)



## Reliable. Precise.

The ElectroCraft size 11 stepper-based linear actuator is ultra-reliable and made to exacting standards incorporating precision materials all designed to provide reliable performance with axial resolution in the microns.

## To build your own linear product, choose the:

**1 - Frame Size**  
(Imperial or Metric)

**2 - Torque**

**3 - Winding**

**4 - Features**  
(see fold-out page 35)

**A P P S** **1 1** **M** — **1 0**      **A** **1 0** — **0** **D** **B** **2** **0** — **X**  
 Product Name      Frame Size      Metric      Holding Torque (Ncm)      Current      Product      Thread      Screw Length      Screw End Mod      Lead Option      Encoder

0 = Linear Actuator  
 1 = Leadscrew Motor  
 2 = Guided Linear Actuator

### Step 1: APPS11M Frame Size Drawing Key

Model	Length	Weight	Holding Torque	Rotor Inertia	A	B	C	D	E	F	G
					Pilot Length	Pilot Diameter	Mount Hole Callout	Mount Hole Spacing	External Flange Dimension	External Nut Thread	Screw End Mod
APPS11M-7	1.24 in (31.5mm)	4.0 oz (110g)	9.5 oz-in (6.7 Ncm)	0.002 oz-in-sec <sup>2</sup> 1.41 <sup>-3</sup> Ncm-sec <sup>2</sup>	2.0 mm	22.00 +0.00 / -0.03 mm	M2.5 x 0.45 mm dia 3.5 mm Deep	23 mm	28 mm	M10 x 1.0	6-32 UNF
APPS11M-10	1.56 in (39.6mm)	5.1 oz (145g)	13.7 oz-in (9.7 Ncm)	0.0035 oz-in-sec <sup>2</sup> 2.47 <sup>-3</sup> Ncm-sec <sup>2</sup>							0.098 / 0.097 in (2.5 mm) Dia Journal

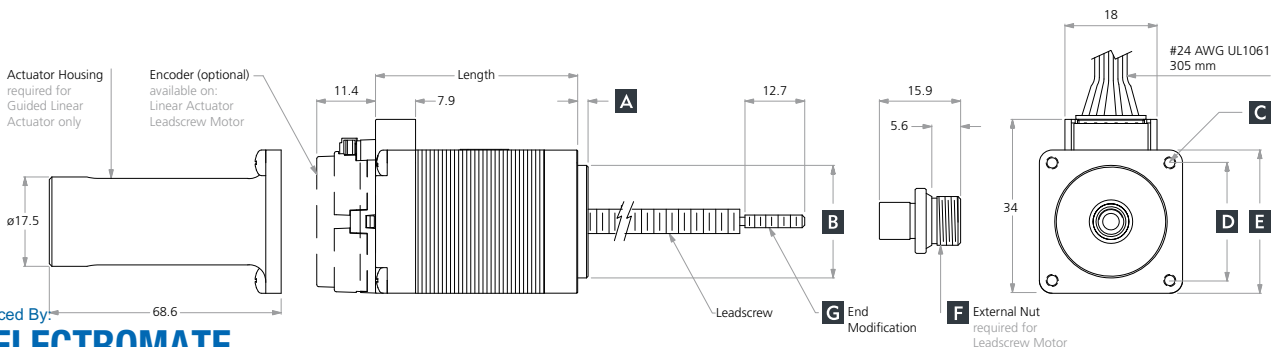

Sold & Serviced By: **ELECTROMATE**

Toll Free Phone (877) SERV098

Toll Free Fax (877) SERV099

Dimensions in millimeters

www.electromate.com

sales@electromate.com



**Step 2: APPS11M Torque and Mechanical Data (Bipolar)**

**APPS11M-7**

Step Angle = 1.8°, 9.5 oz-in hold torque  
 Supply = 48 VDC X 1 amp/phase  
 = 24 VDC X 1 amp/phase

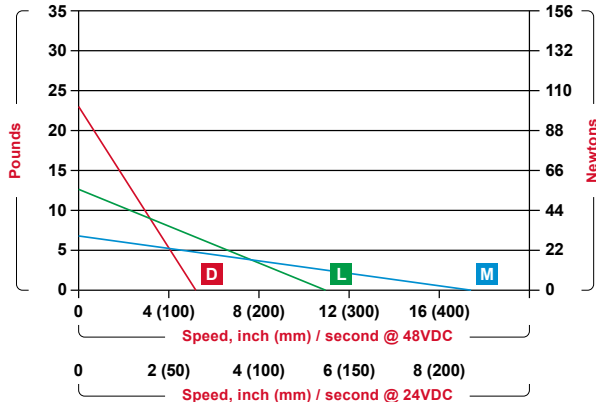

**APPS11M-10**

Step Angle = 1.8°, 9.5 oz-in hold torque  
 Supply = 48 VDC X 1 amp/phase  
 = 24 VDC X 1 amp/phase

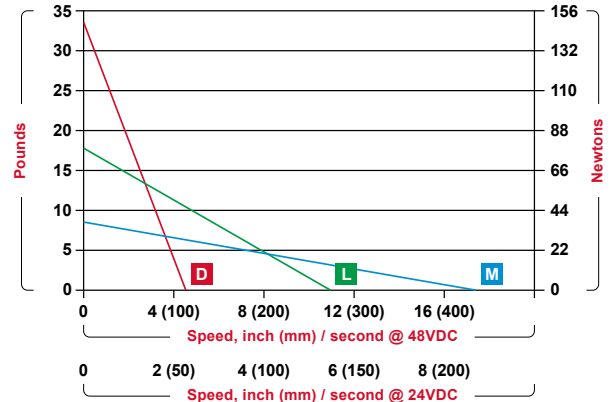

Curves are approximated as straight line for ease of use.

	Thread Designation	Thread Lead Inches (mm) / Rev	Linear Travel Inch (mm) / Full-Step
D	3/16-20 ACME (1S)	0.050 (1.3)	0.00025 (0.0064)
L	3/16-24 ACME (3S)	0.125 (3.2)	0.00063 (0.0160)
M	3/16-24 ACME (8S)	0.333 (8.5)	0.00167 (0.0424)

Motor step rate calculation: Motor step rate (halfstep/sec) = [Speed (in/sec)\*2] / [travel (in/fullstep)] Example "L" thread pitch: @ 2 in/sec = 6,350 halfsteps/sec

**Step 3: Available Windings**

		Metric	7A05	7A10	7A15	10A05	10A10	10A15
Bipolar	Current Bipolar (A/Phase)		0.5	1.0	1.5	0.5	1.0	1.5
	Phase Voltage VDC		5.0	2.5	1.7	6.2	3.1	2.1
	Phase Resistance (ohm)		10.00	2.50	1.10	12.40	3.10	1.40
	Phase Inductance (mH)		6.8	1.5	0.7	10.4	2.7	1.1

Unipolar windings available upon request.



*Still need help?*  
 Easily build your own motor at  
**www.configureamotor.com**



*Need an anti-backlash feature or don't see exactly what you need?*  
 Have ElectroCraft build you a custom winding, stack length or fully customized linear product ... that's our specialty!

## APPS17 & APPS17M : ElectroCraft AxialPower™ Plus | Stepper

Size	Holding Torque oz-in (Ncm)	Linear Speed inch / sec (mm / sec)	Linear Force Pounds (Newton)
NEMA 17, 1.8°	47 (33)	20 (508)	70 (310)



### Precise. Quick.

The ElectroCraft NEMA 17 stepper-based linear actuator is reliable, made to be both precise and responsive with positional accuracy in the microns, load capabilities up to 70 Lbs (32kg), and linear speeds to 12 inches/second (305mm/second).

### To build your own linear product, choose the:

**1 - Frame Size**  
(Imperial or Metric)

**2 - Torque**

**3 - Winding**

**4 - Features**  
(see fold-out page 35)

**a.** **A P P S** **1 7** — **2 9**  
Product Name Frame Size Holding Torque (oz-in)

**b.** **A P P S** **1 7** **M** — **2 1**  
Product Name Frame Size Optional Metric Holding Torque (Ncm)

**A 1 0** — **0 A B 4 0** — **X**  
Current Product Thread Screw Length Screw End Mod Lead Option Encoder

0 = Linear Actuator  
1 = Leadscrew Motor  
2 = Guided Linear Actuator

### Step 1: APPS17 & APPS17M Frame Size Drawing Key

Model	Length	Weight	Holding Torque	Rotor Inertia	A	B	C	D	E	F	G
					Pilot Length	Pilot Diameter	Mount Hole Callout	Mount Hole Spacing	External Flange Dimension	External Nut Thread	Screw End Mod
APPS17-29	1.28 in	7 oz	29 oz-in	0.00053 oz-in-sec <sup>2</sup>	0.08 in	0.8660 in 0.8648 in	[4] 4-40UNC-2B 0.17 in deep	1.22 in	1.65 in	3/8-40 UNF	10-32UNF
APPS17-47	1.52 in	9 oz	47 oz-in	0.00081 oz-in-sec <sup>2</sup>							M5 x 0.8
APPS17M-21	32.5 mm	198 g	21 Ncm	3.74 <sup>-4</sup> Ncm-sec <sup>2</sup>	2.0 mm	22.00 mm 21.96 mm	(4) M3x0.5-6H 3.5 mm deep	31 mm	42 mm	M10x1.25	0.196 / 0.195
APPS17M-33	38.6 mm	255 g	33 Ncm	5.71 <sup>-4</sup> Ncm-sec <sup>2</sup>							(5) dia Journal

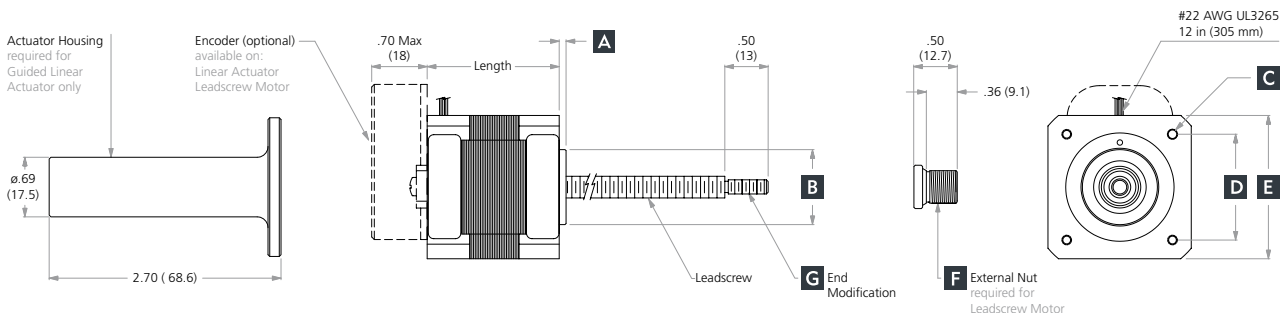

**Step 2: APPS17 & APPS17M Torque and Mechanical Data (Bipolar)**

**APPS17-29  
 APPS17M-21**

Supply = 40 VDC x 2 amp/phase  
 = 24 VDC x 2 amp/phase

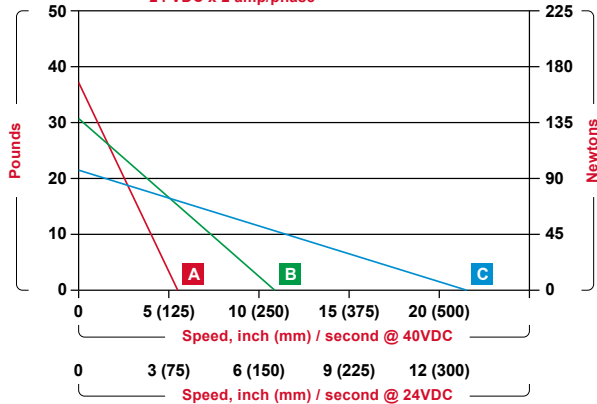

**APPS17-47  
 APPS17M-33**

Supply = 40 VDC x 2 amp/phase  
 = 24 VDC x 2 amp/phase

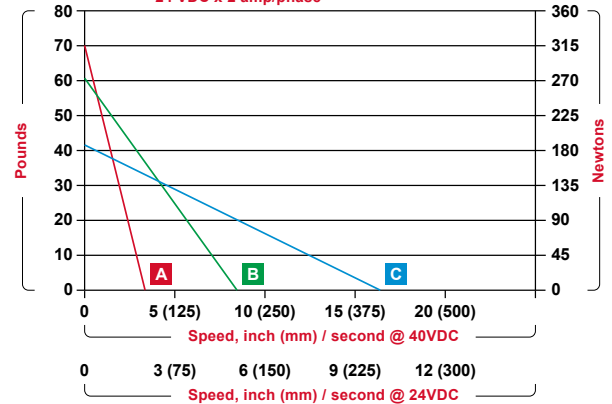

Curves are approximated as straight line for ease of use.

			29A20 (21A20)			47A20 (33A20)		
Thread Designation	Thread Lead Inches (mm) / Rev	Linear Travel Inch (mm) / Full-Step	Y Intercept Pounds (N)	X Intercept 24 Volt	X Intercept 40 Volt	Y Intercept Pounds (N)	X Intercept 24 Volt	X Intercept 40 Volt
J*	1/4-40 UN (1S)	0.02500 (0.6)	40 (180)	1.35 (35)	2.25 (60)	80 (355)	1.00 (25)	1.68 (40)
V*	1/4-32 ACME (1S)	0.03125 (0.8)	38 (170)	1.69 (40)	2.81 (70)	76 (340)	1.25 (30)	2.12 (55)
E*	1/4-20 ACME (1S)	0.05000 (1.3)	37 (165)	2.70 (70)	4.50 (115)	74 (330)	2.00 (50)	3.38 (85)
A	1/4-16 ACME (1S)	0.06250 (1.6)	36 (160)	3.37 (85)	5.62 (140)	72 (320)	2.55 (65)	4.25 (110)
B	1/4-16 ACME (2S)	0.12500 (3.2)	30 (135)	6.75 (170)	11.25 (285)	60 (265)	5.00 (130)	8.44 (215)
F*	1/4-20 ACME (4S)	0.20000 (5.1)	24 (105)	10.80 (275)	18.00 (460)	48 (215)	8.12 (205)	13.50 (340)
C	1/4-16 ACME (4S)	0.25000 (6.4)	20 (90)	13.50 (340)	22.5 (570)	40 (175)	10.12 (260)	16.88 (430)

Motor step rate calculation: Motor step rate (halfstep/sec) = [Speed (in/sec)\*2] / [travel (in/fullstep)] Example "B" thread pitch: @ 2 in/sec = 6,420 halfsteps/sec

**Step 3: Available Windings**

Bipolar	Imperial	29A10	29A15	29A20	47A10	47A15	47A20
	Metric	21A10	21A15	21A20	33A10	33A15	10A20
Current Bipolar (A/Phase)		1.0	1.5	2.0	1.0	1.5	2.0
Phase Resistance (ohm)		3.8	1.90	0.95	4.9	2.4	1.2
Phase Inductance (mH)		4.8	2.3	1.2	9.1	4.9	2.3

Unipolar windings available upon request.  
 \* Consult factory for availability.



*Still need help?*  
 Easily build your own motor at  
**www.configureamotor.com**



*Need an anti-backlash feature or don't see exactly what you need?*  
 Have ElectroCraft build you a custom winding, stack length or fully customized linear product ... that's our specialty!

## APPS23 : ElectroCraft AxialPower™ Plus | Linear Actuator Stepper

Size	Holding Torque oz-in (Ncm)	Linear Speed inch / sec (mm / sec)	Linear Force Pounds (Newton)
NEMA 23, 1.8°	150 (106)	7.5 (190)	175 (780)



### Quick. Powerful.

The ElectroCraft NEMA 23 stepper-based linear actuator is reliable, made to be both responsive and powerful, with positional accuracy in the microns, load capabilities up to 175 Lbs (80kg) and linear speeds to 5 inches/second (130mm/second).

### To build your own linear product, choose the:

**1 - Frame Size**  
(Imperial or Metric)

**2 - Torque**

**3 - Winding**

**4 - Features**  
(see fold-out page 35)

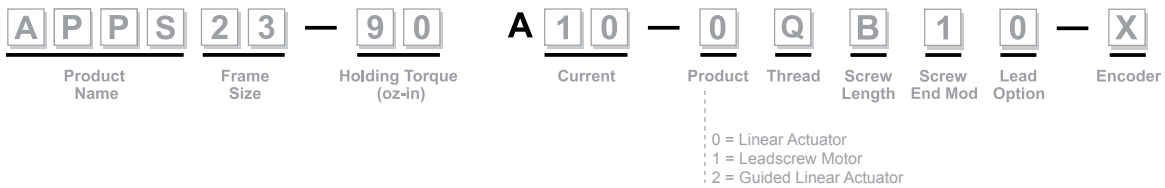

### Step 1:

### APPS23 Frame Size Drawing Key

Model	Length	Weight	Holding Torque	Rotor Inertia	A	B	C	D	E	F	G
					Pilot Length	Pilot Diameter	Mount Hole Callout	Mount Hole Spacing	External Flange Dimension	External Nut Thread	Screw End Mod
APPS23-90	1.28 in (32.5 mm)	7.0 oz (200 g)	90 oz-in (64 Ncm)	0.002 oz-in-sec <sup>2</sup> 1.41 <sup>-3</sup> Ncm-sec <sup>2</sup>	0.06 in (1.5 mm)	1.500 ±0.002 in (38.1 ±0.05 mm)	0.205 ±0.01 in dia (5.21 ±0.25 mm dia)	1.86 in (47 mm)	2.22 in (56 mm)	M17 x 1.0	1/4-28 UNF M6 x 1.0
APPS23-150	1.52 in (38.6 mm)	9.0 oz (255 g)	150 oz-in (106 Ncm)	0.0035 oz-in-sec <sup>2</sup> 2.47 <sup>-3</sup> Ncm-sec <sup>2</sup>							0.235 / 0.236 in dia Journal (5.97 / 5.99 mm)

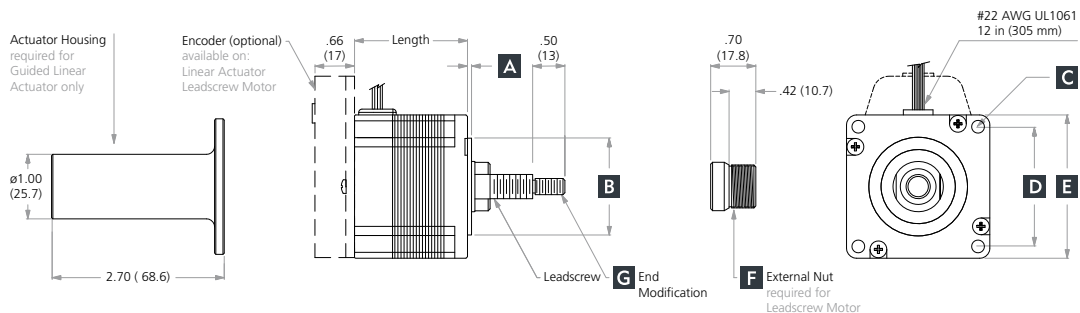

**Step 2: APPS23 Torque and Mechanical Data (Bipolar)**

**APPS23-90**

Step Angle = 1.8°, 90 oz-in hold torque  
 Supply = 80 VDC X 3 amp/phase  
 = 40 VDC X 3 amp/phase

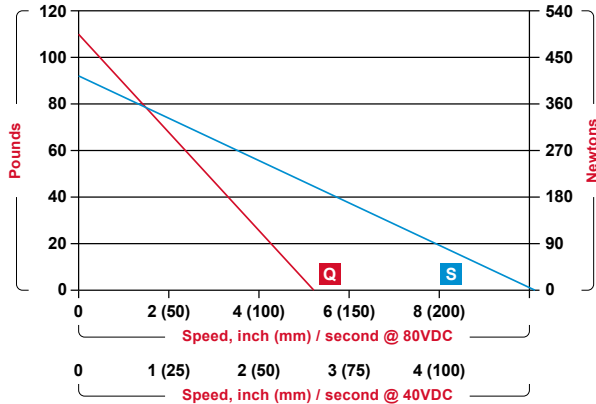

**APPS23-150**

Step Angle = 1.8°, 90 oz-in hold torque  
 Supply = 80 VDC X 3 amp/phase  
 = 40 VDC X 3 amp/phase

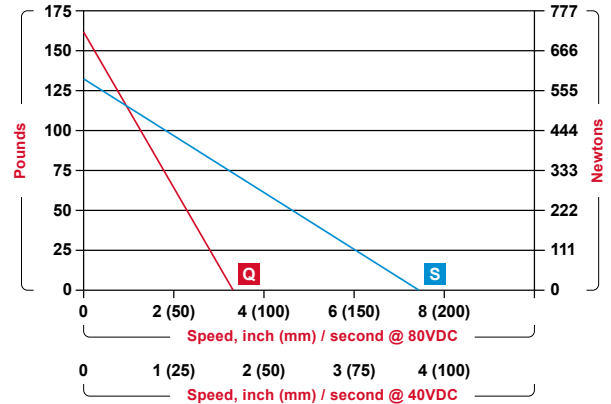

Curves are approximated as straight line for ease of use.

			90A30			150A30		
Thread Designation	Thread Lead Inches (mm) / Rev	Linear Travel Inch (mm) / Full-Step	Y Intercept Pounds (N)	X Intercept 24 Volt	X Intercept 40 Volt	Y Intercept Pounds (N)	X Intercept 24 Volt	X Intercept 40 Volt
<b>Q</b>	3/8-20 ACME (1S)	0.050 (1.3)	109 (30)	2.8 (72)	5.6 (145)	157 (44)	1.9 (50)	3.8 (95)
T*	3/8-16 ACME (1S)	0.063 (1.6)	104 (29)	3.5 (90)	7.0 (180)	151 (42)	2.3 (60)	4.7 (120)
W*	3/8-12 ACME (1S)	0.063 (1.6)	97 (26)	4.7 (120)	9.4 (240)	142 (40)	3.1 (80)	6.3 (160)
<b>S</b>	3/8-10 ACME (1S)	0.100 (2.5)	92 (26)	5.6 (145)	11.2 (285)	130 (36)	3.8 (95)	7.5 (190)
L*	3/8-12 ACME (2S)	0.167 (4.2)	75 (21)	9.4 (240)	18.8 (475)	106 (30)	6.3 (160)	12.5 (320)

Motor step rate calculation: Motor step rate (halfstep/sec) = [Speed (in/sec)\*2] / [travel (in/fullstep)]

Example "S" thread pitch: @ 2 in/sec = 8,000 halfsteps/sec

**Step 3: Available Windings**

		Imperial	90A10	90A20	90A30	150A10	150A20	150A30
<b>Bipolar</b>	Current Bipolar (A/Phase)		1.0	2.0	3.0	1.0	2.0	3.0
	Phase Voltage VDC		5.8	3.0	1.8	7.9	3.8	2.4
	Phase Resistance (ohm)		5.78	1.50	0.60	7.92	1.90	0.80
	Phase Inductance (mH)		20.3	5.2	2.0	35.0	8.6	3.5

Unipolar windings available upon request.

\* Consult factory for availability.



**Still need help?**  
 Easily build your own motor at  
[www.configureamotor.com](http://www.configureamotor.com)



**Need an anti-backlash feature or don't see exactly what you need?**  
 Have ElectroCraft build you a custom winding, stack length or fully customized linear product ... that's our specialty!

## L3S : ElectroCraft 34 Frame | Linear Actuator Stepper

Size	Holding Torque oz-in (Ncm)	Linear Speed inch / sec (mm / sec)	Linear Force Pounds (Newton)
NEMA 34, 1.8°	396 (280)	8.75 (225)	700 (3120)



### Powerful. Robust.

This NEMA 34 stepper-based linear actuator is the workhorse of linear motors. Made to move your most demanding loads with dual front bearings capable of up handling 700 Lbs (320kg) of linear force with precise resolution is a performance to be respected.

### To build your own linear product, choose the:

#### 1 - Frame Size (Imperial or Metric)

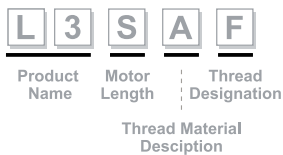

#### 2 - Winding



#### 3 - Features (see fold-out page 35)

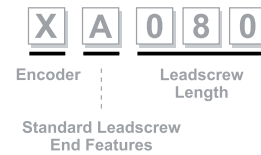

### Step 1: L3S Frame Size Drawing Key

Model	Length	Weight	Holding Torque	Rotor Inertia	A	B	C	D	E	F	G
					Pilot Length	Pilot Diameter	Mount Hole Callout	Mount Hole Spacing	External Flange Dimension	External Nut Thread	Screw End Mod
L3S-90	3.04 in (77.2 mm)	65 oz (1.8 kg)	396 oz-in (280 Ncm)	0.002 oz-in-sec <sup>2</sup> 2.8 <sup>-2</sup> Ncm-sec <sup>2</sup>	0.08 in (2 mm)	2.875 ±0.001 in (73 ±0.025 mm)	0.260 ±0.01 in dia (6.6 ±0.25 mm dia)	2.74 in (69.6 mm)	3.38 in (86 mm)	M17 x 1.0	1/4-28 UNF M6 x 1.0 0.2502 / 0.2499 in dia Journal

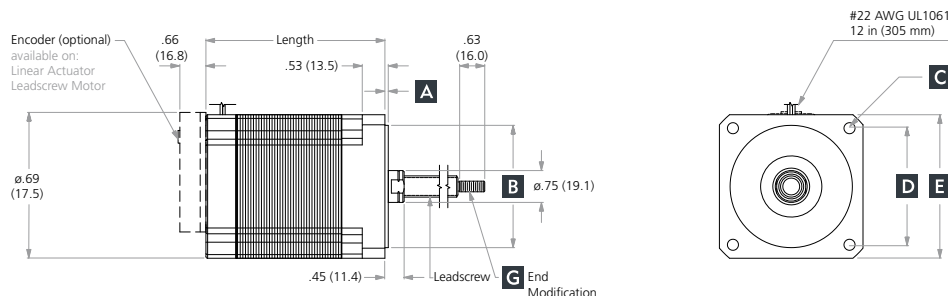

**Step 2: L3S Torque and Mechanical Data (Bipolar)**

**L3SA**

Step Angle = 1.8°, 396 oz-in hold torque  
 Supply = 80 VDC X 3 amp/phase  
 = 40 VDC X 3 amp/phase

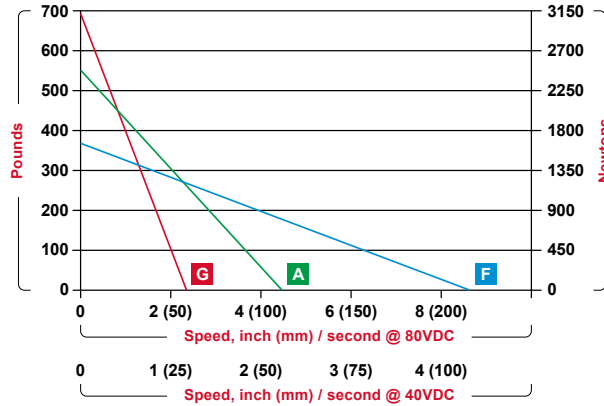

Curves are approximated as straight line for ease of use.

Thread Designation	Thread Lead Inches (mm) / Rev	Linear Travel Inch (mm) / Full-Step
<b>G</b> 1/2-20 ACME (15)	0.05 (1.3)	0.00025 (0.0064)
<b>A</b> 1/2-10 ACME (15)	0.10 (2.5)	0.00050 (0.0127)
<b>F</b> 1/2-10 ACME (25)	0.20 (5.1)	0.00100 (0.0254)

Motor step rate calculation: Motor step rate (halfstep/sec) = [Speed (in/sec)\*2] / [travel (in/fullstep)] Example "A" thread pitch: @ 2 in/sec = 8,000 halfsteps/sec

**Step 3: Available Windings**

Bipolar	Imperial	M200	M300	M500
	Current Bipolar (A/Phase)	2.0	3.0	5.0
	Phase Voltage VDC	5.0	3.0	2.0
	Phase Resistance (ohm)	2.50	1.00	0.40
	Phase Inductance (mH)	21.9	8.7	3.4

Unipolar winding available for OEM application upon request.



*Still need help?*  
 Easily build your own motor at  
**www.configureamotor.com**



*Need an anti-backlash feature or don't see exactly what you need?*  
 Have ElectroCraft build you a custom winding, stack length or fully customized linear product ... that's our specialty!

## APPD15 & APPD15M : ElectroCraft AxialPower™ | Linear Actuator PMDC

Size	Peak Torque oz-in (Ncm)	Linear Speed inch / sec (mm / sec)	Linear Force Pounds (Newton)
15 FRAME	45 (32)	2.5 (64)	70 (315)



### Simple. Direct.

The ElectroCraft 15 frame PMDC based linear actuators offers a simple on/off control for direct axial movement. Whether replacing an air cylinder, or introducing a simple electric actuator to your system, this simple, low cost solution is a reliable alternative.

### To build your own linear product, choose the:

**1 - Frame Size**  
(Imperial or Metric)

**2 - Torque**

**3 - Winding**

**4 - Features**  
(see fold-out page 35)

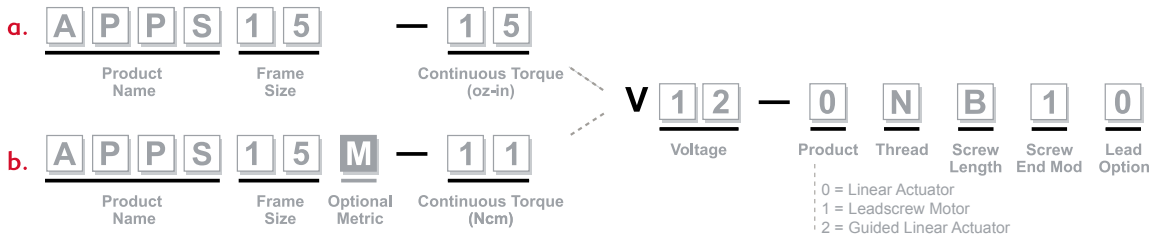

### Step 1: APPD15 & APPD15M Frame Size Drawing Key

Model	Length	Weight	Peak Torque	Constant Stall Torque	A	B	C	D	E	F	G
					Pilot Length	Pilot Diameter	Mount Hole Callout	Mount Hole Spacing	External Flange Dimension	External Nut Thread	Screw End Mod
APPD15	3.99 in	22.4 oz	45 oz-in	10 oz-in	0.08 in	1.05 ±0.01 in	0.180 in dia #8-32 tapped	see diagram	2.74 x 1.54 in	3/8-40 UNS-2A	6-32 UNC 0.098/0.097 in dia Journal
APPD15M	101.2 mm	0.63 kg	32 Ncm	7 Ncm	2 mm	26.67 ±0.25 mm	4.57 mm dia M4X0.7 tapped	see diagram	69.6 x 39.1 mm	M10x7.5	M2.4x0.45 2.5 mm dia Journal

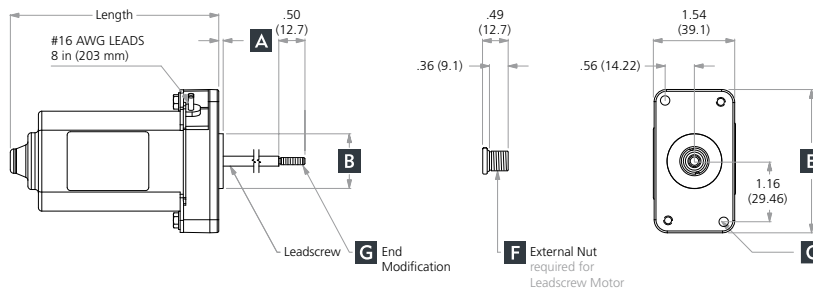

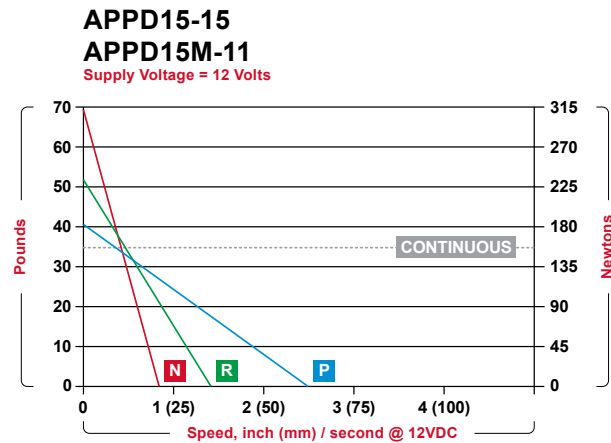

**Step 2: APPD15 & APPD15M Torque and Mechanical Data (Bipolar)**

Curves are approximated as straight line for ease of use.

Thread Designation	Thread Lead Inches (mm) / Rev
<b>N</b> 10-32 (15)	0.03 (0.762)
<b>R</b> 10-32 (25)	0.06 (1.524)
<b>P</b> 10-32 (45)	0.13 (3.302)

**Step 3: Available Windings**

Imperial	15V12
Metric	11V12
Voltage (Vdc)	12.0
Voltage Constant V/KRPM	3.2
Torque Constant oz-in/A (Ncm/A)	4.3 (3)
Max Continuous Current (A)	3.7
Peak Current (A)	10.0

\* 24 Volt windings for OEM applications are available upon request.



*Still need help?*  
 Easily build your own motor at  
**www.configureamotor.com**



*Need an anti-backlash feature or don't see exactly what you need?*  
 Have ElectroCraft build you a custom winding, stack length or fully customized linear product ... that's our specialty!

## APPD25 & APPD25M : ElectroCraft AxialPower™ | Linear Actuator PMDC

Size	Peak Torque oz-in (Ncm)	Linear Speed inch / sec (mm / sec)	Linear Force Pounds (Newton)
25 FRAME	215 (152)	1.6 (40)	180 (810)



### Simple. Direct.

The ElectroCraft 25 frame PMDC based linear actuators offers a simple on/off control for direct axial movement. Whether replacing an air cylinder, or introducing a simple electric actuator to your system, this simple, low cost solution is a reliable alternative.

### To build your own linear product, choose the:

**1 - Frame Size**  
(Imperial or Metric)

**2 - Torque**

**3 - Winding**

**4 - Features**  
(see fold-out page 35)

**a.** A P P D 2 5      —      2 5  
 Product Name      Frame Size      Continuous Torque (oz-in)

**b.** A P P D 2 5 M      —      1 8  
 Product Name      Frame Size      Optional Metric      Continuous Torque (Ncm)

**V** 2 4      —      0 A B 4 0  
 Voltage      Product      Thread      Screw Length      Screw End Mod      Lead Option

0 = Linear Actuator  
 1 = Leadscrew Motor  
 2 = Guided Linear Actuator

### Step 1: APPD25 & APPD25M Frame Size Drawing Key

Model	Length	Weight	Peak Torque	Constant Stall Torque	A	B	C	D	E	F	G
					Pilot Length	Pilot Diameter	Mount Hole Callout	Mount Hole Spacing	External Flange Dimension	External Nut Thread	Screw End Mod
APPD25	4.02 in	41.6 oz	142 oz-in	30 oz-in	0.08 in	1.25 ±0.005 in	#8-32 UNC-2B X 0.25 deep	1.414 in (2.0 BC)	2.52 in	3/8-40 UNS-2A	10-32 UNC 0.196/195 in dia Journal
APPD25M	102 mm	1.2 kg	100 Ncm	21 Ncm	2 mm	31.75 ±0.13 mm	M5x0.8 x 6.35mm deep	35.91 mm (50.8 BC)	64 mm	M10x7.5	M5x0.8 4.98/4.95 mm dia Journal*

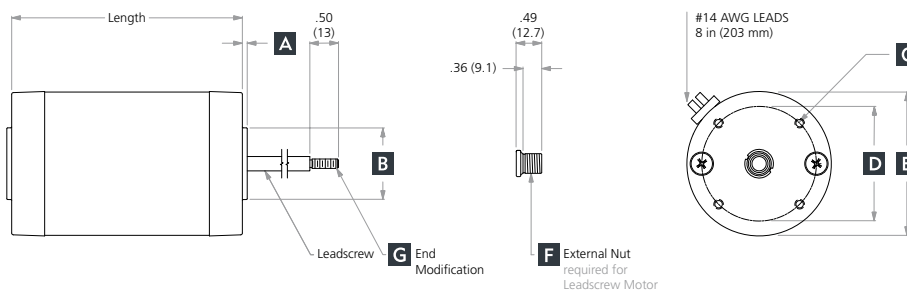

**Step 2: APPD25 & APPD25M Torque and Mechanical Data (Bipolar)**

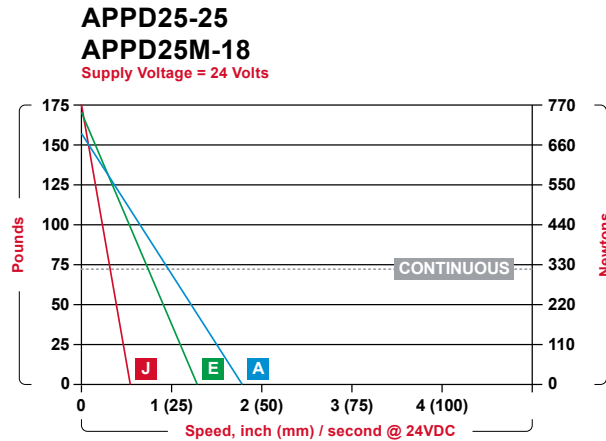

Curves are approximated as straight line for ease of use.

Thread Designation	Thread Lead Inches (mm) / Rev
<b>J</b> 1/4-40 UNS-2A	0.03 (0.762)
<b>E</b> 1/4-20 ACME	0.05 (1.27)
<b>A</b> 1/4-16 ACME	0.06 (1.524)

**Step 3: Available Windings**

	25V12*	25V24
Imperial	25V12*	25V24
Metric	18V12*	18V24
Voltage (Vdc)	12.0	24.0
Voltage Constant V/KRPM	3.3	6.6
Torque Constant oz-in/A (Ncm/A)	4.4 (3.1)	8.9 (6.2)
Max Continuous Current (A)	9.2	4.6
Peak Current (A)	32.0	16.0

\* 12 Volt windings for OEM applications are available upon request. More coarse threads (increased speed).



**Still need help?**  
 Easily build your own motor at  
[www.configureamotor.com](http://www.configureamotor.com)



**Need an anti-backlash feature or don't see exactly what you need?**  
 Have ElectroCraft build you a custom winding, stack length or fully customized linear product ... that's our specialty!

## SA45 : Electrocraft CompletePower™ | Stepper Drive

Power Supply Voltage	Nominal Current	Phases	Operation Mode		Special Functions		
			Fullstep	Micro stepping	Integrated Oscillator	Current Fallback	Anti-Resonance Anti-Noise
11 - 48	5 / 10	2	●	●	●	●	●



### For Stepper Motors. Up to 480W.

This bipolar stepper drive provides microstepping to 1/16 built into a fully enclosed rugged aluminum case. It can be DIN-rail mounted or panel mounted for fast integration. The mode of operation is set by simple DIP switches. Features include an internal oscillator that allows operation of the drive at a internal speed set point or with an external analog speed reference that can scale this set point. Both the 5 A and 10 A versions of this drive can be powered by the same range of voltage supplies. This drive is protected against over-current and overtemperature and incorporates the state of the art dual full bridge MOSFET driver for maximum efficiency. Connectivity is tool-free with RJ45-CAT5 plugs for the control inputs and push-type terminals for power.

### Drive Model Example

<b>S</b>	<b>A</b>	<b>4</b>	<b>5</b>	<b>10</b>
Drive Technology	Revision	# Quadrants	Voltage 10x VDC	Nominal Amps

### SA45 Outline Drawing

Model	A	B	C	Weight oz (g)
	Length in (mm)	Width in (mm)	Height in (mm)	
SA4505	4.69 (119.0)	3.35 (85.0)	1.08 (28)	7.05 (200)
SA4510				7.76 (220)

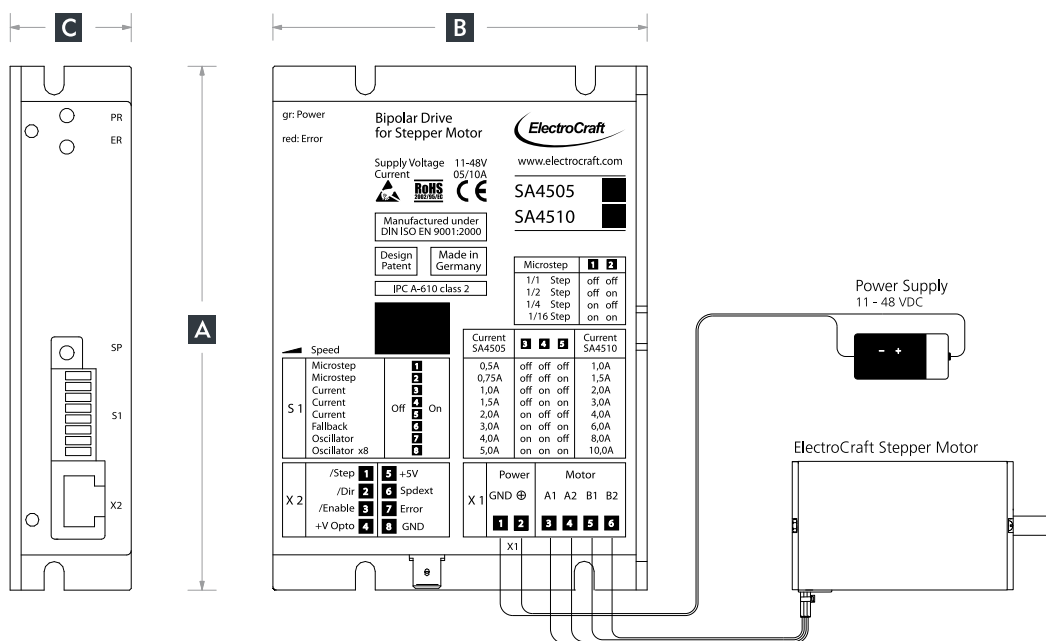

SA45 Specifications					
Model Number	Power Supply Voltage (VDC)	Nominal Current (Amps)	Max. Power with Heatsink (Watts)	Frequency of power output stage (kHz)	Efficiency (%)
SA4505	11 - 48	5	240	50	95
SA4510	11 - 48	10	480	50	95
Control Inputs					
Enable			Optical, Ri = 1 kOhm; max. 20 mA		
Direction			Optical, Ri = 1 kOhm; max. 20 mA		
Step			Optical, Ri = 1 kOhm; max. 20 mA; 250 kHz		
Speed ext.			+1 to +5 VDC; Ri = 100 kOhm		
Switches					
Microstep			1/1; 1/2; 1/4; 1/16		
Current			0,5 A to 5 A / 1 A to 10 A		
Fallback			on / off		
Oscillator			on / off		
Oscillator x8			on / off		
Outputs					
Auxiliary voltage source +5V			+5 VDC / 50 mA		
Fault			Optical, max. 20 mA		
Display					
LEDs			green= Power / red = Error		
Function of Potentiometers					
Speed			Range: 4 Hz - 500kHz / 40 Hz - 4800 Hz		
Ambient conditions					
Operation temperature (°C)			-10 to +45		
Storage temperature (°C)			-40 to +85		
Humidity Range Not Condensing (%rel)			20 to 80 % rel.		
Mode of Operation					
Fullstep; Microstep: 1/2, 1/4, 1/16					

Available Accessories for SA45 (details see page 36)						
IA210x	CAxxx	HA3008	HA3018	HA3028	MA0025	WA2509
						

## SA49 : Electrocraft CompletePower™ | Stepper Drive



Power Supply Voltage	Nominal Current	Phases	Operation Mode		Special Functions		
			Fullstep	Micro stepping	Integrated Oscillator	Current Fallback	Anti-Resonance Anti-Noise
24 - 90	5	2	●	●	●	●	●

### For Stepper Motors. Up to 450W.

This bipolar stepper drive provides microstepping to 1/16 built into a fully enclosed rugged aluminum case. It can be DIN-rail mounted or panel mounted for fast integration. The mode of operation is set by simple DIP switches. Features include an internal oscillator that allows operation of the drive at a internal speed set point. The current setting, internal speed and ramp time can easily be selected using BCD input switches then toggled into memory. This drive is protected against over-current and over-temperature and incorporates the state of the art dual full bridge MOSFET driver for maximum efficiency. Connectivity is tool-free with RJ45-CAT5 plugs for the control inputs and push-type terminals for power.

### Drive Model Example

<b>S</b>	<b>A</b>	<b>4</b>	<b>9</b>	<b>05</b>
Drive Technology	Revision	# Quadrants	Voltage 10x VDC	Nominal Amps

### SA49 Outline Drawing

Model	A	B	C	Weight oz (g)
	Length in (mm)	Width in (mm)	Height in (mm)	
SA4905	4.69 (120.0)	3.35 (85.0)	1.08 (27.5)	7.76 (220)

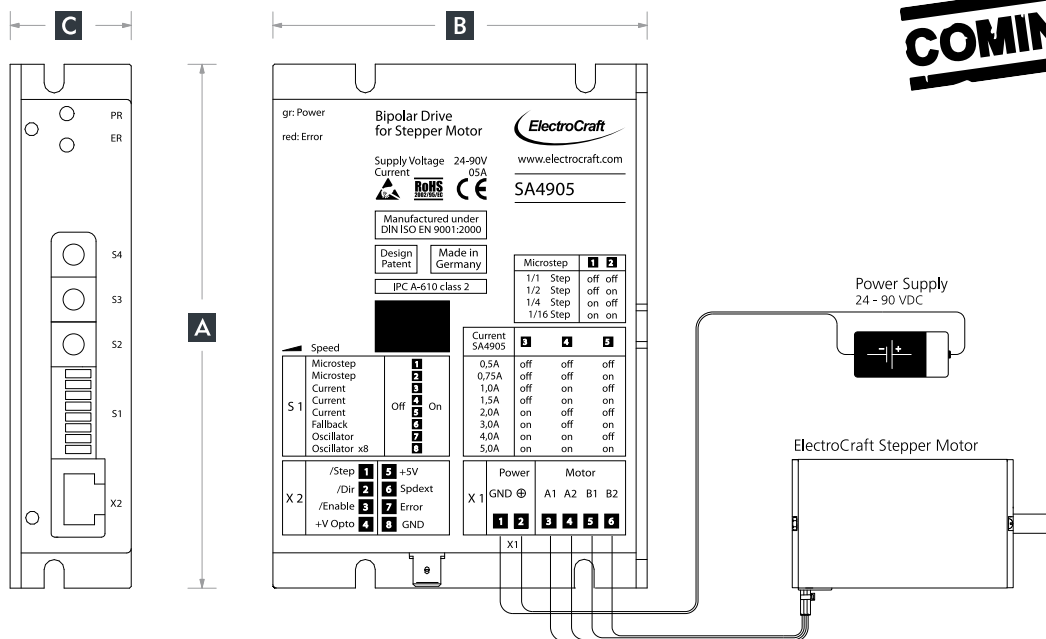

**COMING SOON**

## SA49 Specifications







Model Number	Power Supply Voltage (VDC)	Nominal Current (Amps)	Max. Power with Heatsink (Watts)	Frequency of power output stage (kHz)	Efficiency (%)
SA4905	24 - 90	5	450	50	95
Control Inputs					
Enable			Optical, Ri = 1 kOhm; max. 20 mA		
Direction			Optical, Ri = 1 kOhm; max. 20 mA		
Step (250 kHz)			Optical, Ri = 1 kOhm; max. 20 mA		
Switches					
Microstep			1/1; 1/2; 1/4; 1/16		
Current Set			idle / set		
Fallback			on / off		
Speed Set			idle / set		
I/O voltage			int / ext		
Enable			int / ext		
BCD Select			Speed / Current / Ramp		
Outputs					
Auxiliary voltage source +5V			+5 VDC / 50 mA		
Fault			Optical, max. 20 mA		
Display					
LEDs			green = Ready / red = Error		
Function of Potentiometers					
Speed			Range: 1,5 Hz - 1,2 kHz / 12 Hz - 9,6 kHz		
Ambient conditions					
Operation temperature (°C)			-10 to +45		
Storage temperature (°C)			-40 to +85		
Humidity Range Not Condensing (%rel)			20 to 80 % rel.		
Mode of Operation					

Fullstep; Microstep: 1/2, 1/4, 1/16

The information on these pages represents data that is preliminary in nature and is subject to change. Please contact the factory for the most current information.

**COMING SOON**

## Available Accessories for SA49 (details see page 36)

IA210x	CAxxx	HA3008	HA3018	HA3028	MA0025	WA2509
						

## DA43 : Electrocraft CompletePower™ | Servo Amplifier

Power Supply Voltage	Nominal Current	Quadrants	Operation Mode					
			Torque Control	Analog Pos.	Speed Control			
					I x R Comp.	DC-Tacho	Voltage	Encoder
11 – 30	3	4	●		●	●	●	



### For Brush-Commutated Linear PMDC Motors. Up to 75 W.

This servo-amplifier is built into a fully enclosed rugged miniature aluminum case. Linear servo amplifiers are ideal for low friction applications requiring high bandwidth, low noise and minimal distortion from the power electronics. The drive can be configured in the following modes of operation with simple dip switch settings: I/R compensation, Tach mode, Voltage mode and Torque mode. Input power of 30 VDC combined with a mountable heat-sink provides up to 75 Watts of power. Inputs include current limit, max set value and gain functions. The drive handles continuous currents up to 3 A. The linear power stage is protected against over-current and over-temperature.

### Drive Model Example

<b>D</b> Drive Technology	<b>A</b> Version	<b>4</b> # Quadrants	<b>3</b> Voltage 10x VDC	<b>03</b> Current Amps
------------------------------	---------------------	-------------------------	-----------------------------	---------------------------

### DA43 Outline Drawing

Model	A	B	C	Weight oz (g)
	Length in (mm)	Width in (mm)	Height in (mm)	
DA4303	4.13 (105)	2.56 (65)	1.08 (28)	4.94 (140)

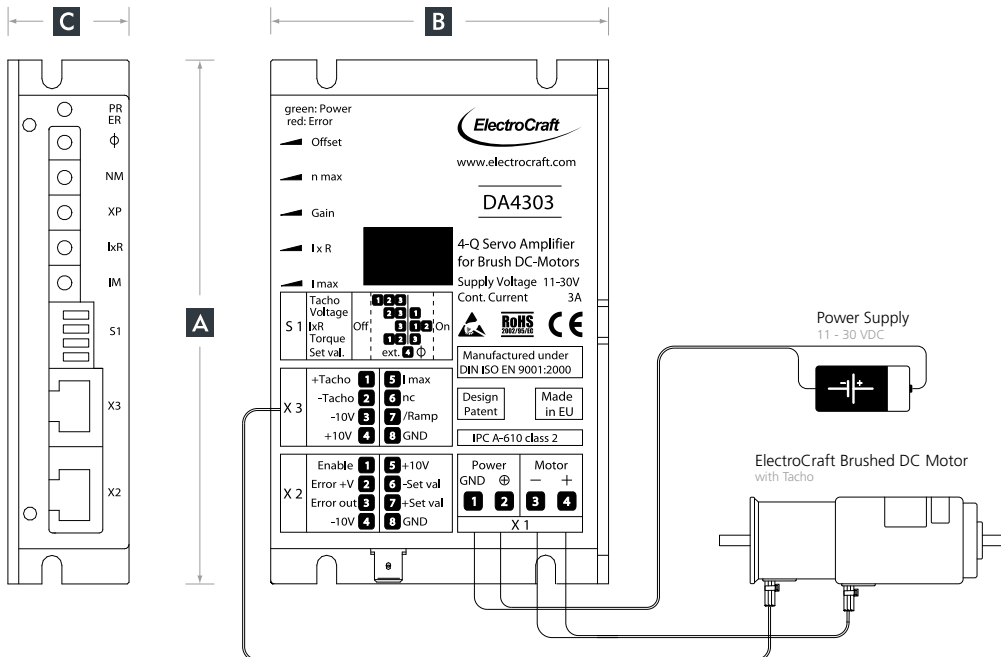



DA43 Specifications					
Model Number	Power Supply Voltage (VDC)	Aux. Voltage Verror (VDC)	Nominal Current (Amps)	Max. Power with Heatsink (Watts)	Efficiency (%)
DA4303	11 - 30	5 - 30	3	75	97
Control Inputs					
Set value			-10 to +10 VDC; Ri = 20 kOhm		
Imax			0 to +10 VDC; Ri > 10 kOhm		
Tacho			max. 50 VDC; Ri = 75 kOhm		
Enable			TTL/ +24 VDC; Ri = 47 kOhm		
Ramp			active LO; Ri = 100 kOhm		
Switches					
Tacho-, Voltage-, IxR-, Torque-Mode			Not set / Set		
Set value via Offset			extern / intern		
Outputs					
Auxiliary voltage source			+10 VDC / 10 mA each		
Auxiliary voltage source			+10 VDC / 10 mA each		
Error			TTL / 24 VDC; Ri = 50 Ohm		
Display					
LEDs			green = Power / red = Error		
Potentiometers					
Function of Potentiometer			Offset; nmax; Gain; IxR; Imax		
Ambient conditions					
Operation temperature (°C)			-10 to +45		
Storage temperature (°C)			-40 to +85		
Humidity Range Not Condensing (%rel)			20 to 80 % rel.		
Mode of Operation					
Speed-control by voltage	Torque-control	IxR-compensation	Speed-control by DC-tacho		

## Available Accessories for DA43 (details see page 36)

ASO-BM-70-30	CAxxxx	MA0025	WA2509
			
HA2008	HA2018	HA2028	
			

## DA47 : Electrocraft CompletePower™ | Servo Amplifier

Power Supply Voltage	Nominal Current	Quadrants	Operation Mode					
			Torque Control	Analog Pos.	Speed Control			
					I x R Comp.	DC-Tacho	Voltage	Encoder
11 - 70	9 / 18	4	●		●	●	●	



### For Brush-Commutated PMDC Motors. Up to 1260 W.

This four-quadrant PWM brush DC servo amplifier is fully enclosed in a small, rugged aluminum case which can be DIN-rail mounted or panel mounted for easy integration. The drive can be configured in the following modes of operation with simple dip switch settings: I/R compensation, Tach mode, Voltage mode and Torque mode. Both the 9 A and 18 A versions have twice the rated current available as peak current for intermittent overload conditions. This drive is protected against over-current and over-temperature and incorporates state of the art MOSFET technology for maximum efficiency. Connectivity is tool-free with RJ-45-connectors for input/outputs and push-type terminals for supply power and motor connections.

### Drive Model Example

<b>D</b> Drive Technology	<b>A</b> Version	<b>4</b> # Quadrants	<b>7</b> Voltage 10x VDC	<b>09</b> Current Amps
------------------------------	---------------------	-------------------------	-----------------------------	---------------------------

### DA47 Outline Drawing

Model	A	B	C	Weight oz (g)
	Length in (mm)	Width in (mm)	Height in (mm)	
DA4709	4.69 (119)	3.35 (85)	1.08 (28)	7.76 (220)
DA4718				

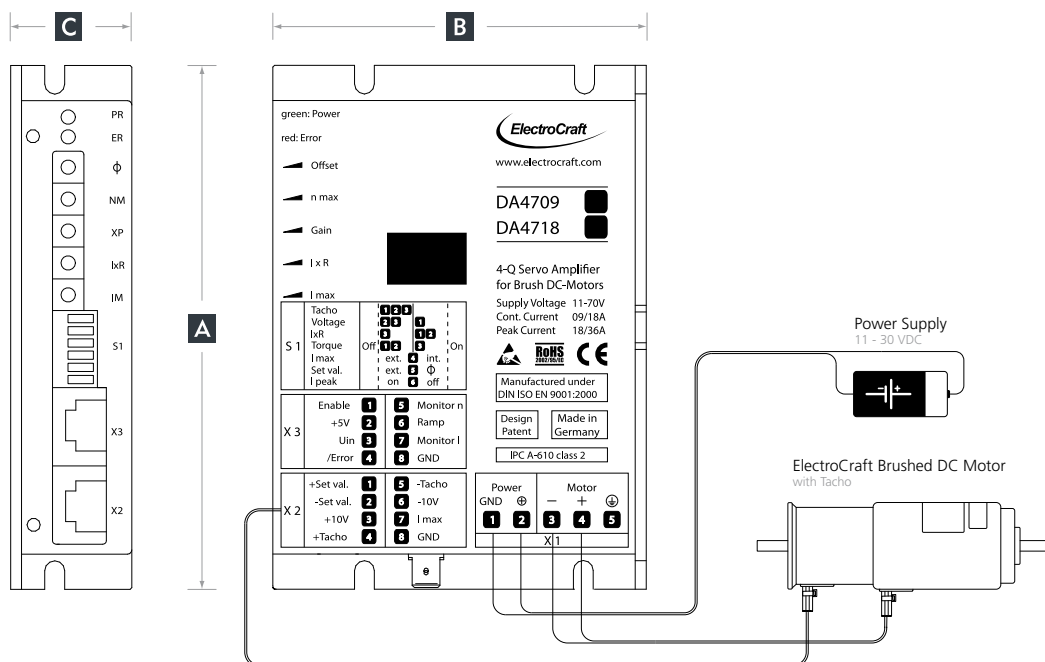

## DA47 Specifications

Model Number	Power Supply Voltage (VDC)	Aux. Voltage Verror (VDC)	Nominal Current (Amps)	Peak current (Amps)	Max. Power with Heatsink (Watts)	Frequency of power output stage (kHz)	Efficiency (%)
DA4709	11 - 70	5 - 30	9	18	630	50	95
DA4718			18	36	1260		
Control Inputs							
Set value				-10 to +10 VDC; Ri = 20 kOhm			
Tacho				max. 50 VDC; Ri = 50 kOhm			
Enable				TTL/ +24 VDC; Ri = 4.7 kOhm			
I Limit				intern / extern			
Ramp				TTL / +24 VDC; Ri = 4.7 kOhm			
Imax				0 to +10 VDC; Ri > 100 kOhm			
Switches							
Tacho-, Voltage-, IxR-, Torque-Mode				Not set / Set			
Set value via Offset				extern / intern			
I peak				on / off			
Outputs							
Auxiliary voltage source				+5 VDC / 50 mA			
Auxiliary voltage sources				±10 VDC / 20 mA			
Monitor I				1 / 0.5 V/A; Ri = 100 Ohm			
Monitor n				0.1 V / 1 Vmotor ; Ri = 100 Ohm			
Supervisory output /Error				Open Collector / Push Pull / TTL / +24V; Ri = 50 Ohm			
Display							
LEDs				green = Power / red = Error			
Potentiometers							
Function of Potentiometer				Offset; nmax; Gain; IxR; Imax			
Ambient conditions							
Operation temperature (°C)				-10 to +45			
Storage temperature (°C)				-40 to +85			
Humidity Range Not Condensing (%rel)				20 to 80 % rel.			
Mode of Operation							
Speed-control by voltage		Torque-control		IxR-compensation		Speed-control by DC-tacho	

## Available Accessories for DA47 (details see page 36)

ASO-BM-70-30	IA210x	CAxxxx	HA3008	HA3018	HA3028	MA0025	WA2509
							

## SCA-L : Electrocraft CompletePower™ | Servo Amplifier

Model	Power Supply Voltage	Nominal Current	Quadrants	Operation Mode					
				Torque Control	Analog Pos.	Speed Control			
						I x R Comp.	DC-Tacho	Voltage	Encoder
SCA-LE-30-03	11 - 30	3	4						●
SCA-LS-30-03	11 - 30	3	4	●		●	●	●	



### For Brush-Commutated PMDC Motors. Up to 75 W.

This linear four-quadrant brushless DC servo amplifier is fully enclosed in a rugged aluminum case which can be panel mounted for easy integration. The drive is available in several configurations depending on your control requirements. The drive handles continuous currents up to 3 Amps and is protected against over-current, over-temperature and motor short-circuit.

### Drive Model Example



### SCA-L Outline Drawing

Model	A	B	C	Weight oz (g)
	Length in (mm)	Width in (mm)	Height in (mm)	
SCA-LE-30-03	4.76 (121)	3.94 (100)	1.57 (40)	13.40 (380)
SCA-LS-30-03				11.64 (330)

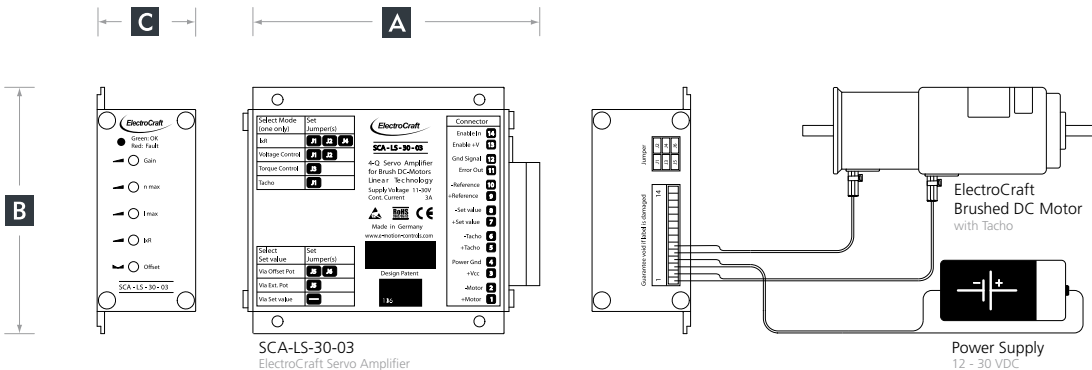
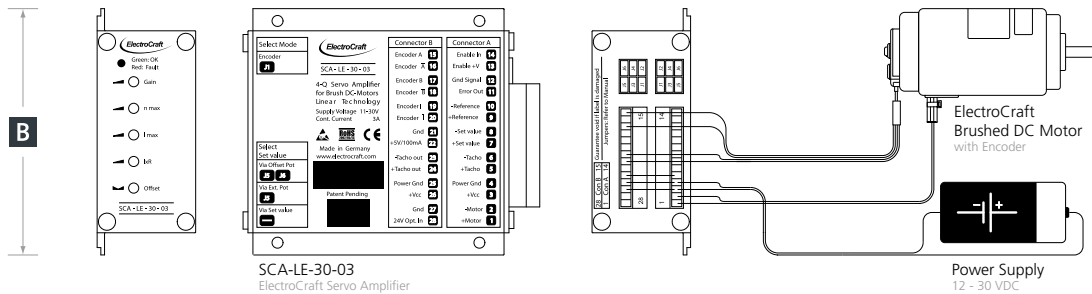

SCA-L Specifications			
Model Number	Power Supply Voltage (VDC)	Nominal Current (Amps)	Max. Power with Heatsink (Watts)
SCA-LE-30-03	11 - 30	3	75
SCA-LS-30-03			
Control Inputs			
Set value		-10 to +10 VDC; Ri = 100 kOhm	
Tacho		max. 50 VDC; Ri = 50 kOhm	
Enable		+8 to +30 VDC; Ri = 5 kOhm	
Encoder input signals (SCA-LE only)		Channel A & /A; B & /B; I & /I; max. 600 kHz ; TTL/ +5 to +24 VDC; Ri > 10 kOhm	
Outputs			
Auxiliary voltage source for encoder (SCA-LE only)		+5 VDC / 100 mA	
Auxiliary voltage source		+3,9 VDC / 20 mA	
Auxiliary voltage source		-3,9 VDC / 20 mA	
Auxiliary voltage source Enable +V		Connected with 4.7 kOhm to +VCC	
Error		Open Collector max. +30 VDC; 20 mA	
Display			
LEDs		green = OK / red = Fault	
Potentiometers			
Function of Potentiometer		Gain; nmax; lmax; lxR; Offset	
Ambient conditions			
Operation temperature (°C)		-10 to +45	
Storage temperature (°C)		-40 to +85	
Humidity Range Not Condensing (%rel)		20 to 80 % rel.	
Mode of Operation			
SCA-LE-30-03	Speed-control by Digital-Encoder		
SCA-LS-30-03	Speed-control by voltage	Torque-control	lxR-compensation
			Speed-control by DC-tacho

## Available Accessories for SCA-L (details see page 36)

ASO-BM-70-30



ASX-RM-01-01



## SCA-S : Electrocraft CompletePower™ | Servo Amplifier

Model	Power Supply Voltage	Nominal Current	Quadrants	Operation Mode					
				Torque Control	Analog Pos.	Speed Control			
						I x R Comp.	DC-Tacho	Voltage	Encoder
SCA-SE-30-06	11 - 30	6	4						●
SCA-SS-30-06	11 - 30	6	4	●		●	●	●	



### For Brush-Commutated PMDC Motors. Up to 150 W.

This PWM four-quadrant brushless DC servo amplifier is fully enclosed in a rugged aluminum case which can be panel mounted for easy integration. The drive is available in several configurations depending on your control requirements. The drive handles continuous currents up to 6 Amps and is protected against over-current, over-temperature and motor short-circuit .

### Drive Model Example



### SCA-S Outline Drawing

Model	A	B	C	Weight oz (g)
	Length in (mm)	Width in (mm)	Height in (mm)	
SCA-SE-30-06	4.76 (121)	3.94 (100)	1.57 (40)	13.76 (390)
SCA-SS-30-06				12.00 (340)

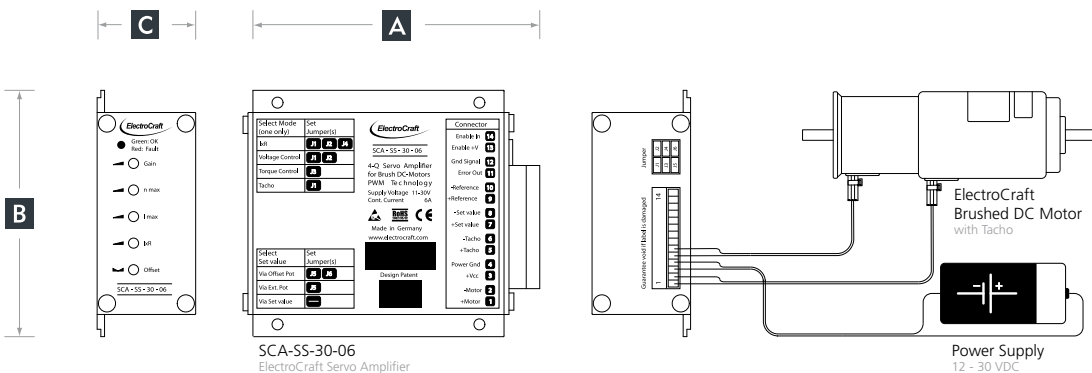
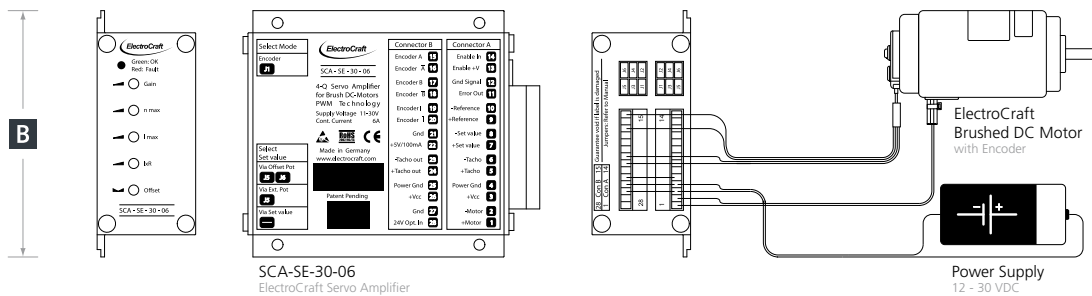

### SCA-S Specifications

Model Number	Power Supply Voltage (VDC)	Nominal Current (Amps)	Max. Power with Heatsink (Watts)	Frequency of power output stage (kHz)	Efficiency (%)
SCA-SE-30-06	11 - 30	6	150	50	95
SCA-SS-30-06					
Control Inputs					
Set value			-10 to +10 VDC; Ri = 100 kOhm		
Tacho			max. 50 VDC; Ri = 50 kOhm		
Enable			+8 to +30 VDC; Ri = 5 kOhm		
Encoder input signals (SCA-SE only)			Channel A & /A; B & /B; I & /I; max. 600 kHz ; TTL/ +5 to +24 VDC; Ri > 10 kOhm		
Outputs					
Auxiliary voltage source			+3.9 VDC / 20 mA		
Auxiliary voltage source			-3.9 VDC / 20 mA		
Auxiliary voltage source for encoder (SCA-SE only)			+5 VDC / 100 mA		
Auxiliary voltage source Enable +V			Connected with 27 kOhm to +VCC		
Supervision output /Error			Open Collector max. +30 VDC; 20 mA		
Display					
LEDs			green = OK / red = Fault		
Potentiometers					
Function of Potentiometer			Gain; nmax; lmax; lxR; Offset		
Ambient conditions					
Operation temperature (°C)			-10 to +45		
Storage temperature (°C)			-40 to +85		
Humidity Range Not Condensing (%rel)			20 to 80 % rel.		
Mode of Operation					
SCA-SE-30-06	Speed-control by Digital-Encoder				
SCA-SS-30-06	Speed-control by voltage	Torque-control	lxR-compensation	Speed-control by DC-tacho	

### Available Accessories for SCA-S (details see page 36)

ASO-BM-70-30	ASX-RM-01-01	IA210x
		



## GO FIGURE.

Customize your options ...

To easily find a motor / motion system that best meets your needs:

- Step 1: Select a base technology
- Step 2: Select a model type & features
- Step 3: Select a performance
- Step 4: Select an electrical winding
- Step 5: Select any options & accessories



Easily build your own motor at  
[www.configureamotor.com](http://www.configureamotor.com)

## Build Your Own ElectroCraft Motor To Fit Your Exact Application

For the past 60 years, the global team at ElectroCraft has helped engineers like you translate innovative ideas into reality. To build on that legacy, we created this Build-Your-Own ElectroCraft Motor web tool to get you started with our technology.

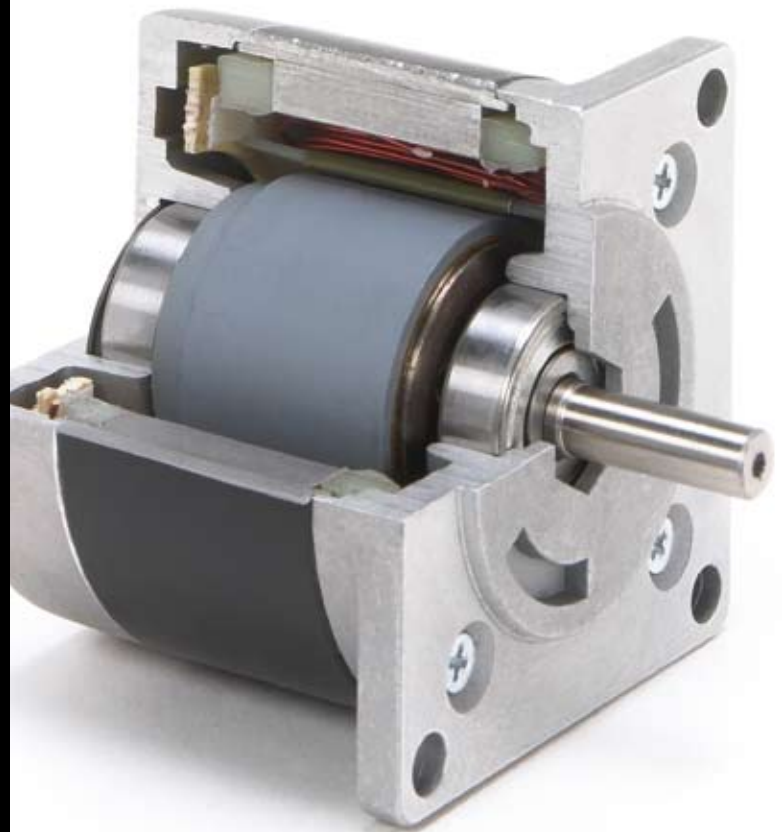

A web configuration tool from ElectroCraft ... Go Figure!  
**Your Genius. Our Drive.**



## System Matrix - Matching Linear Product and Drive Combinations

	Linear Product		Drive Models							
	Motor P/N		Bipolar Stepper Drive			PMDC Servo Drive				
	Imperial	Metric	SA4505	SA4510	SA4905	DA4303	DA4709	DA4718	SCA-LS-30-03	SCA-SS-30-06
AxialPower Stepper (APPS)		APPS11M-7A05	●		●					
		APPS11M-7A10	●		●					
		APPS11M-7A15	●		●					
		APPS11M-10A05	●		●					
		APPS11M-10A10	●		●					
		APPS11M-10A15	●		●					
		APPS17-29A10	APPS17M-21A10	●		●				
		APPS17-29A15	APPS17M-21A15	●		●				
		APPS17-29A20	APPS17M-21A20	●		●				
		APPS17-47A10	APPS17M-33A10	●		●				
		APPS17-47A15	APPS17M-33A15	●		●				
		APPS17-47A20	APPS17M-33A20	●		●				
		APPS17-58A10	APPS17M-41A10	●		●				
		APPS17-58A15	APPS17M-41A15	●		●				
		APPS17-58A20	APPS17M-41A20	●		●				
		APPS23-90A10	APPS23M-64A10	●		●				
		APPS23-90A20	APPS23M-64A20	●		●				
		APPS23-90A30	APPS23M-64A30	●		●				
		APPS23-150A10	APPS23M-106A10	●		●				
		APPS23-150A20	APPS23M-106A20	●		●				
	APPS23-150A30	APPS23M-106A30	●		●					
L3-Series Stepper		L3SAF-M200	●		●					
		L3SAF-M300	●		●					
		L3SAF-M500		●						
AxialPower PMDC (APPD)		APPD15-10V120						●		●
		APPD15-10V240				●		●	●	
		APPD25-30V120						●		
		APPD25-30V240					●			●



*Still need help?*  
 Easily build your own motor at  
**[www.configureamotor.com](http://www.configureamotor.com)**



*Need an anti-backlash feature or don't see exactly what you need?*  
 Have ElectroCraft build you a custom winding, stack length or fully customized linear product ... that's our specialty!



## Other Products available from ElectroCraft:

- CompletePower™ I Motion Control
- TorquePower™ I Steppers
- RapidPower™ I BLDC
- DirectPower™ I PMDC
- MobilePower™ I Transmissions
- SolidPower™ Plus I Housed AC
- SurePower™ I C-Frame AC



## CompletePower™ I Drives



With meticulous engineering and advanced electronics, our CompletePower speed controls and servo drives offer reliability and precision servo motion control. From sensitive medical dosing systems to rugged professional power tools, our CompletePower devices can handle a wide variety of applications.

## AxialPower™ I Linear Actuator



PMDC, and BLDC motors, our family of AxialPower linear actuators are built to last. Our unique approach to linear motion with low-friction, polymer rotating nuts and stainless steel leadscrews provides high force and linear precision in the smallest packages available.

### TorquePower™ | Steppers



With non-cumulative position accuracies as low as  $\pm 3\%$ , the precision of our TorquePower motor is matched only by the dependability of its performance. Bi-directional operation and enclosed, permanently lubricated ball bearings provide long-lasting, smooth operation.

### RapidPower™ | BLDC



Our BLDC motors provide the rapid acceleration and consistent speed needed for applications from centrifuges to x-y positioning systems. The RapidPower product line ensures a steady operation at any speed by utilizing sealed ball bearings and reduced torque ripple from skewed magnetization.

### DirectPower™ | PMDC



Dynamically balanced armatures and precision ball bearings ensure that the DirectPower line maintains its characteristically smooth performance. This durable, totally enclosed, non-ventilated (TENV) motor is available in a broad product line from lower cost, general purpose options to high performance PMDC servo motors.

### MobilePower™ | Transmissions



With a choice of output ratios, our MobilePower line of products helps power battery-operated vehicles from wheelchairs to lift trucks. And, to increase durability and decrease noise levels, the robust all metallic gears are hobbed to a precision AGMA 9-Class.

### SolidPower™ Plus | Housed AC



High starting torques and stator windings matched to your application ensure the SolidPower product provides lasting performance. The dynamically balanced, skewed rotor bars and precision-machined fits keep vibration levels at a minimum.

### SurePower™ | C-Frame AC



Our AC shaded-pole motor, the SurePower product, can be utilized for a wide range of air-moving applications - perfect for the rigors of refrigeration and commercial food equipment applications.

**Step 4: Features**

<b>0</b> Product	<b>A</b> Thread	<b>B</b> Screw Length	<b>4</b> Screw End Mod	<b>0</b> Lead Option	<b>X</b> Encoder
---------------------	--------------------	--------------------------	---------------------------	-------------------------	---------------------

Product	Thread
0 Linear Actuator	Please refer to product pages.
1 Leadscrew Motor	
2 Guided Linear Actuator	

Screw Options		End Mod Options			Lead Options		Encoder Options		
#	Length	#	Nominal Diameter	End Modification	Length of End Mod.	#	Line count		
X	No leadscrew	1	screw Ø 10-32 + 3/16	6-32 UNC	0.50 inch	0	flying leads	X	No Encoder
A	3.00	2	screw Ø 10-32 + 3/16	M2.4 X 0.45	0.50 inch	1	connector	G	250
B	6.00	3	screw Ø 10-32 + 3/16	0.098/0.097 Dia [2.5mm]	0.50 inch			H	400
C	12.00	4	screw Ø 1/4	10-32 UNF	0.50 inch			J	500
D	18.00	5	screw Ø 1/4	M5 X 0.8	0.50 inch			K	1000
E	24.00	6	screw Ø 1/4	0.196/0.195 Dai [5mm]	0.50 inch			L	2000
		7	screw Ø 3/8	1/4-28 UNF	0.50 inch			M	5000
		8	screw Ø 3/8	M6 X 1.0	0.50 inch			L	2000
		9	screw Ø 3/8	0.235/0.236 Dia [6mm]	0.50 inch			M	5000





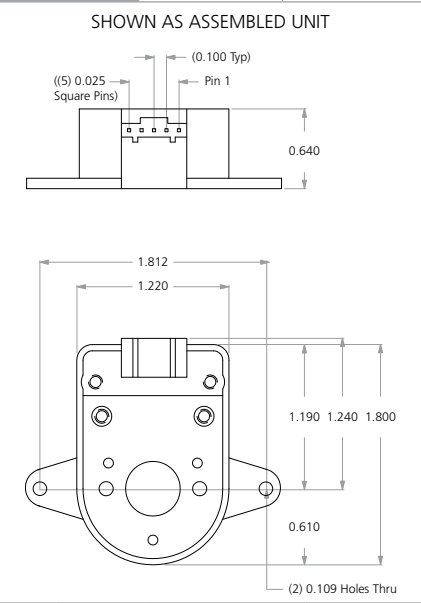
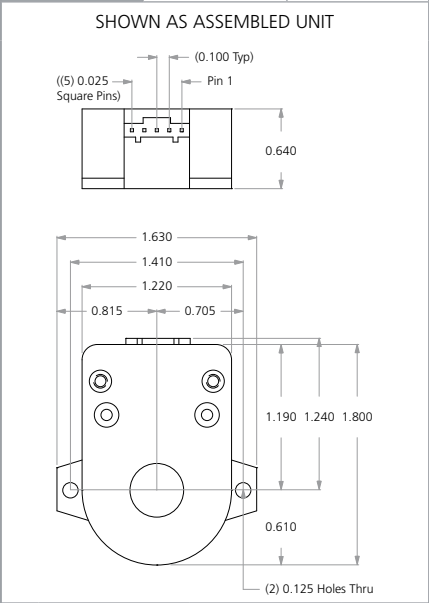
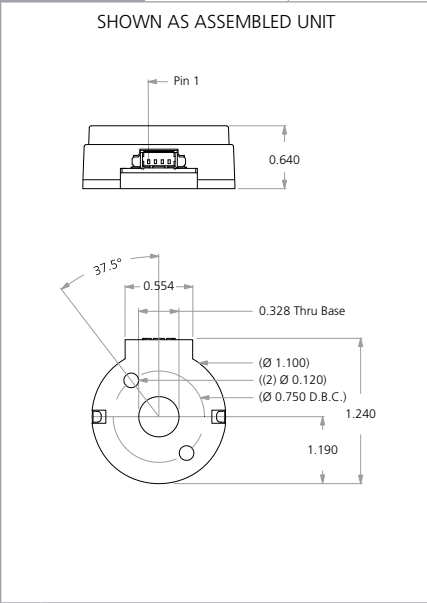







**Encoder Specifications for APPS11M, APPS17(M), APPS23 and L3S**

Motor Size	Encoder	Line Count	Motor Size	Encoder	Line Count	Motor Size	Encoder	Line Count
APPS11M	H	400	APPS17	H	400	APPS23 L3S	H	400
	K	1000		K	1000		K	1000



#	Parameter	#	Parameter	Max Current Draw	Typ Current Draw	Supply Voltage	Mating Connector (Ref)	Contact (Ref)
1	+5 VDC	1	Ground	85 ma	55 ma	5V	AMP P/N: 104257-4	AMP P/N 104480-4
2	Channel A	2	Index					
3	Ground	3	Channel A					
4	Channel B	4	+5 VDC					
		5	Channel B					

Additional product features for OEM applications available upon request

Drive Accessories					
Patch Cable					
	P/N	50cm	100cm	200cm	300cm
	Red	CA2005	CA2010	CA2020	CA2030
	Yellow	CA4005	CA4010	CA4020	CA4030
	Gray	CA8005	CA8010	CA8020	CA8030
Aluminium Din Rail kit			Braking module		
	Aluminium Din Rail kit with L-shaped bracket for units: SCA-Lx / SCA-Sx (not used for SCA-SS-70-30)	P/N ASX-RM-01-01			Braking module in a rugged aluminium case. DA-Series SCA-Series  P/N ASO-BM-70-30
Passive heatsink			Passive heatsink		
	Passive heatsink optimized for drives: DA43	P/N HA2008			Passive heatsink optimized for drives: SA45 SA49 DA47  P/N HA3008
Fanned heatsink			Fanned heatsink		
	One fan heatsink optimized for drives (fan is 1 x 24 VDC, .8 W): DA43	P/N HA2018			One fan heatsink optimized for drives (fan is 1 x 24 VDC, .8 W): SA45 SA49 DA47  P/N HA3018
Fanned heatsink			Fanned heatsink		
	Two fan heatsink optimized for drives (fans are 2 x 24 VDC, .8 W): DA43	P/N HA2028			Two fan heatsink optimized for drives (fans are 2 x 24 VDC, .8 W): SA45 SA49 DA47  P/N HA3028
Choke module			DIN Rail mounting kit		
	Choke module optimized for PMDC drives. Inductance: IA2100 = 2x50 µH; IA2101 = 2x100 µH Nominal current: 10 A  DA-Series SCA-Series	P/N IA210x			DIN Rail mounting kit for units: DA-Series EA-Series  P/N MA0025
Break Out Board			DIN Rail mounting kit		
	Break Out Board for: DA-Series EA-Series	P/N WA2509			DIN Rail mounting kit for: ASO-BM-70-30  P/N MA3050